

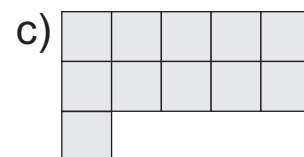

Vogelperspektive

Stelle dir das Würfelgebäude von oben vor und finde die passende Ansicht!

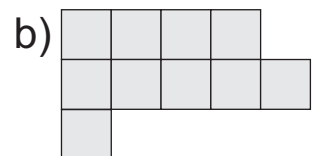

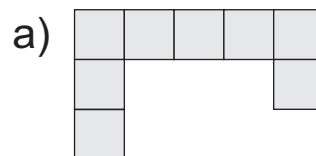
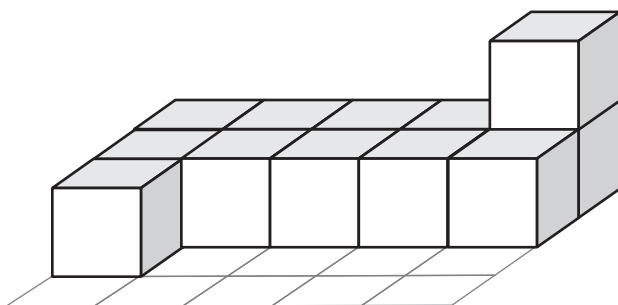
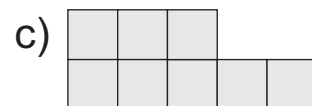
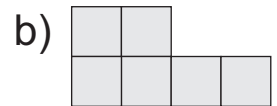
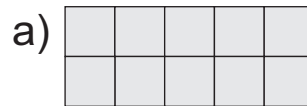
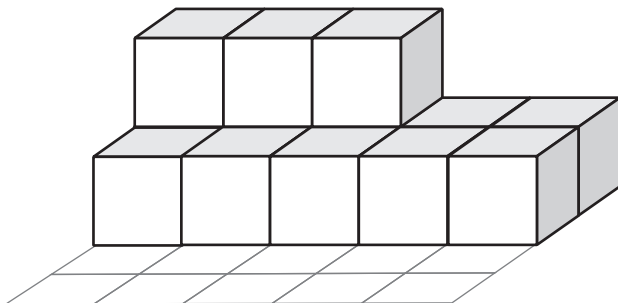
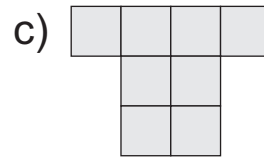
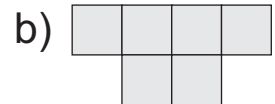
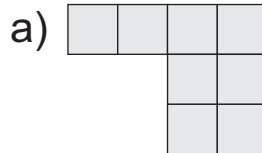
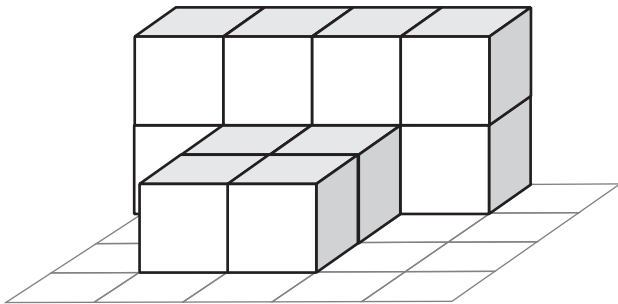

Vogelperspektive

Stelle dir das Würfelgebäude von oben vor und finde die passende Ansicht!

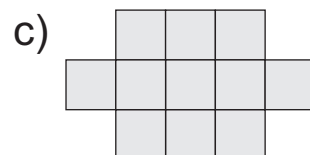
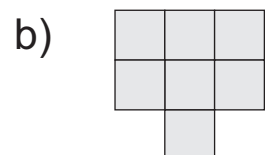
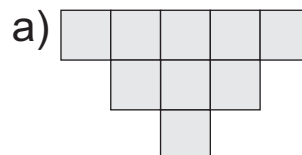
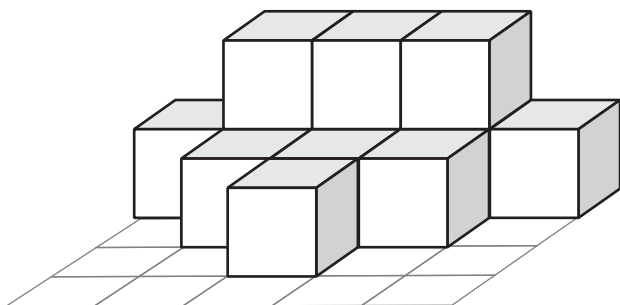
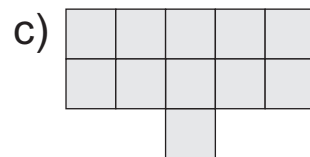
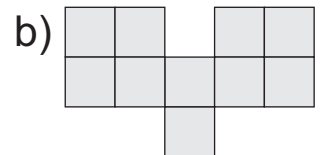
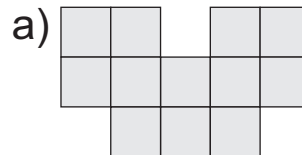
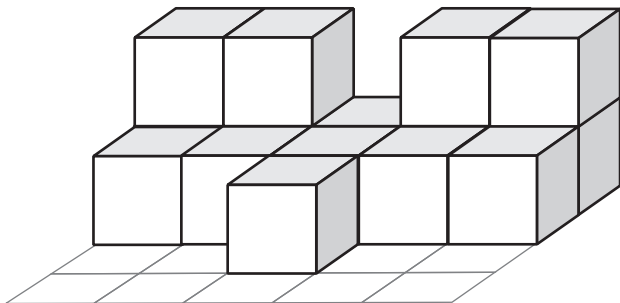
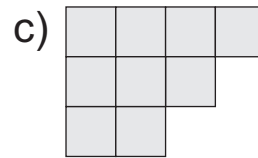
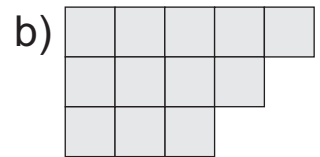
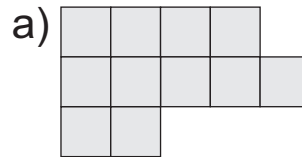
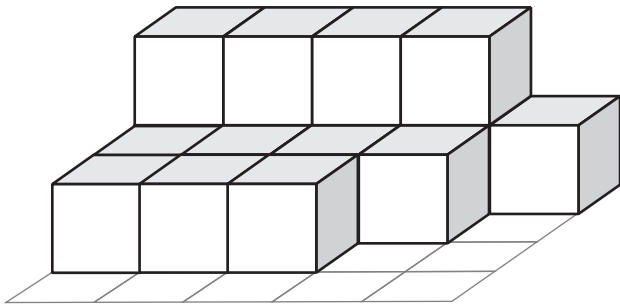



Vogelperspektive

Beispiel:

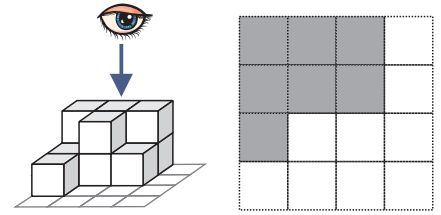

Zeichne das Bauwerk so in das Gitterfeld ein, wie man es von oben sieht.

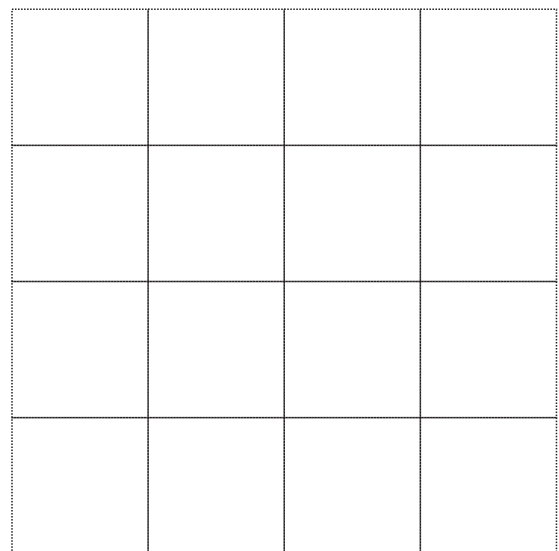
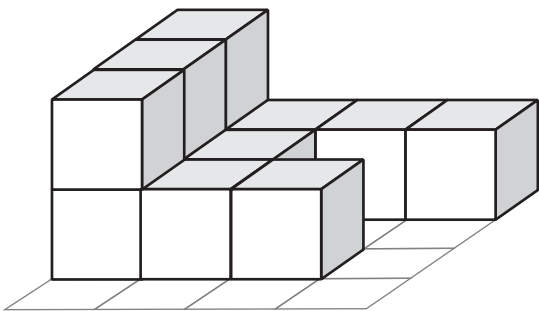
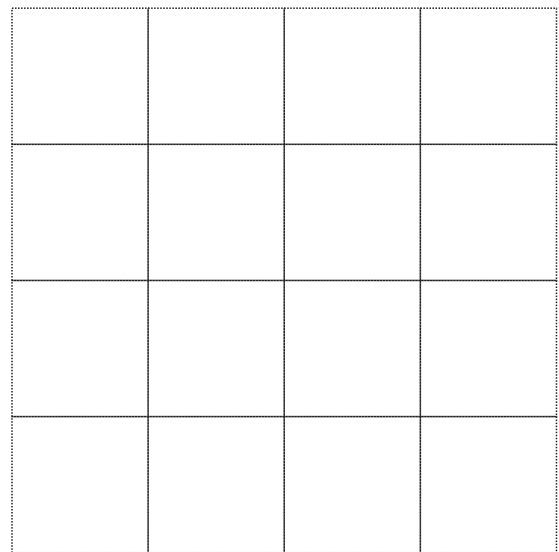
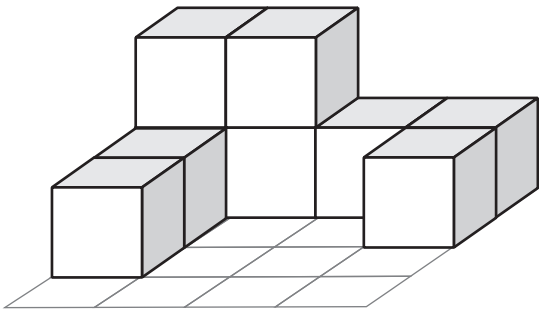



Vogelperspektive

Beispiel:

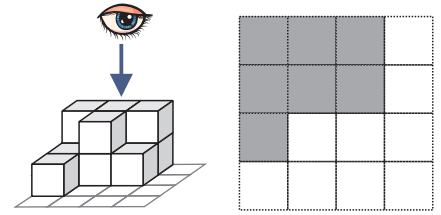

Zeichne das Bauwerk so in das Gitterfeld ein, wie man es von oben sieht.

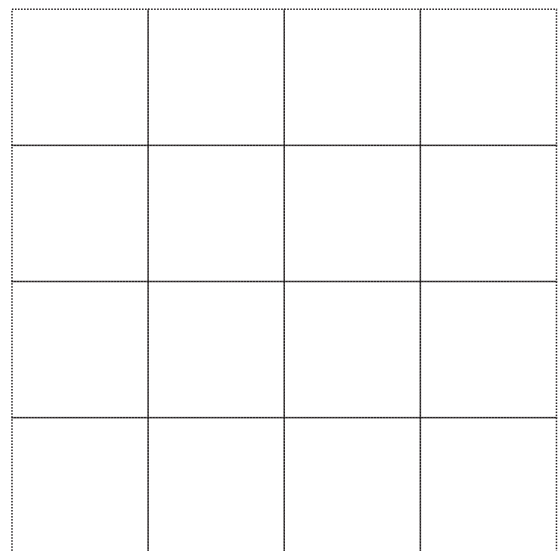
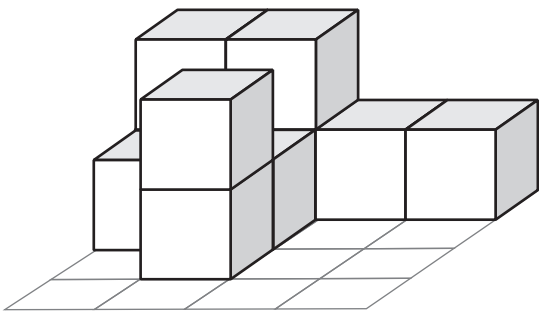
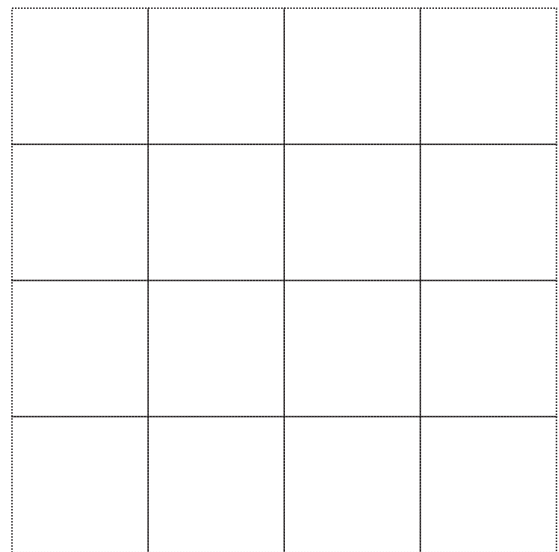
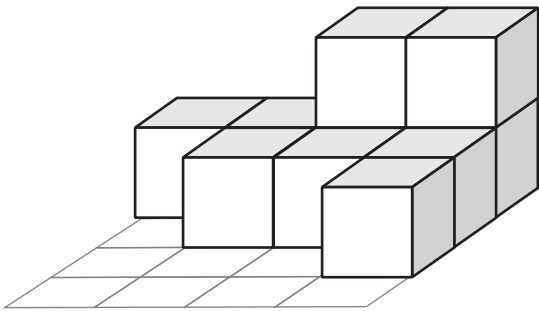



Vogelperspektive

Beispiel:

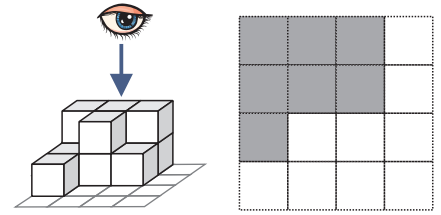

Zeichne das Bauwerk so in das Gitterfeld ein, wie man es von oben sieht.

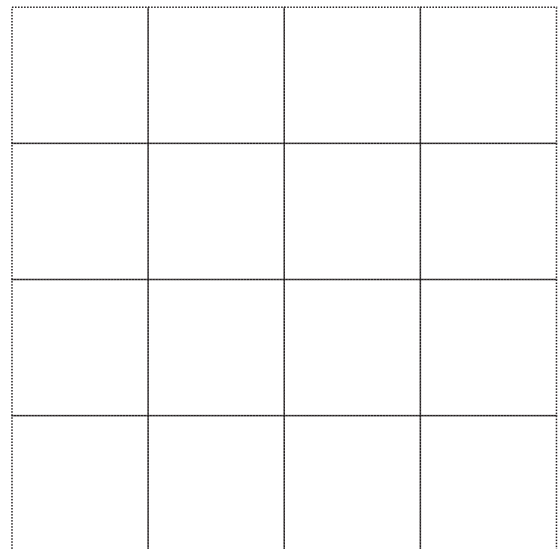
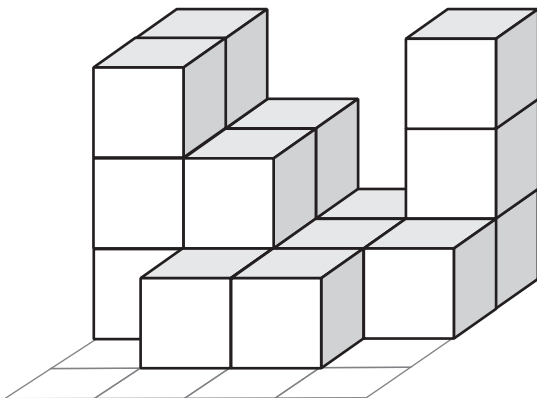
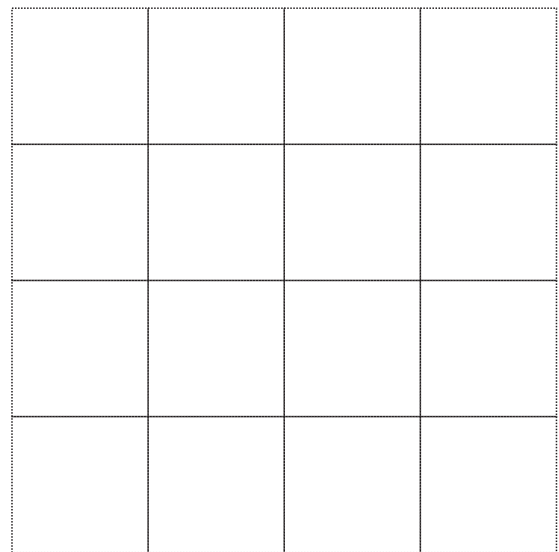
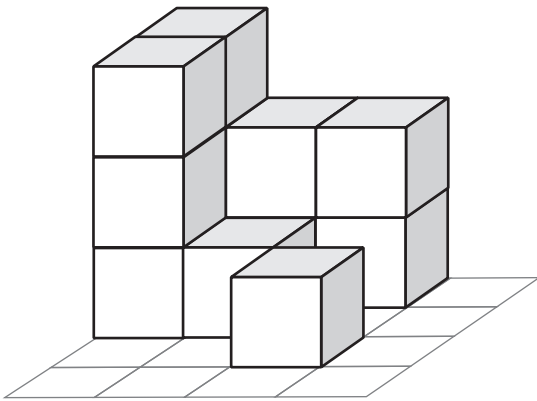



Vogelperspektive



Stelle dir das Würfelgebäude von oben vor und finde die passende Ansicht!

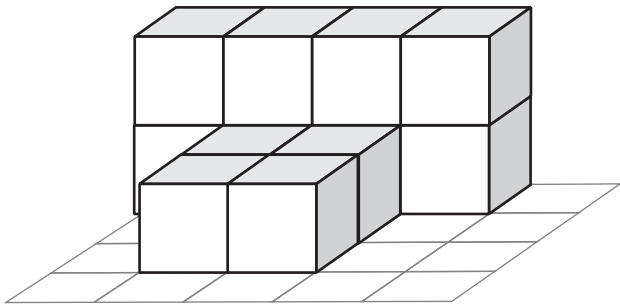

- a)
- b)
- c)

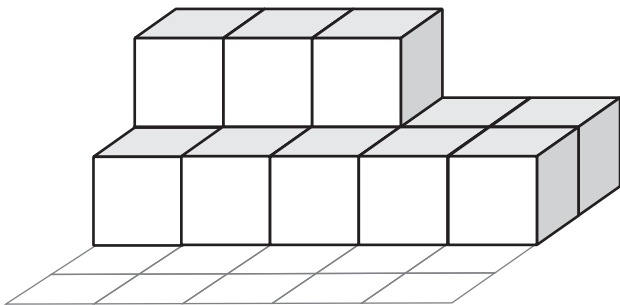

- a)
- b)
- c)

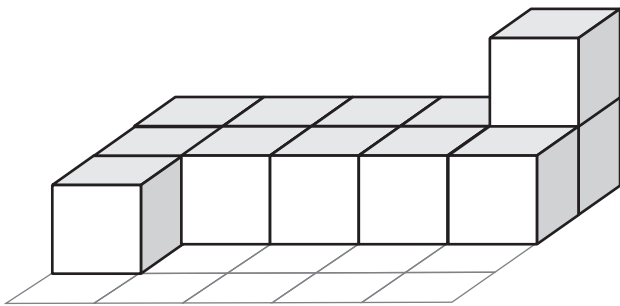

- a)
- b)
- c)



Vogelperspektive



Stelle dir das Würfelgebäude von oben vor und finde die passende Ansicht!

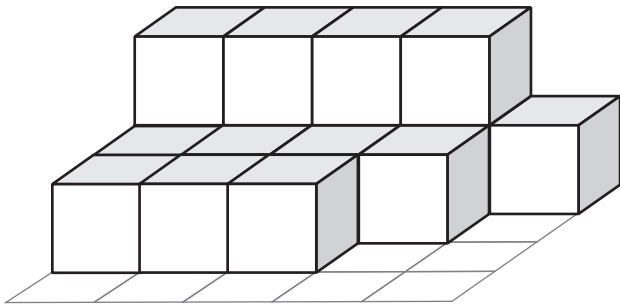

- a)
- b)**
- c)

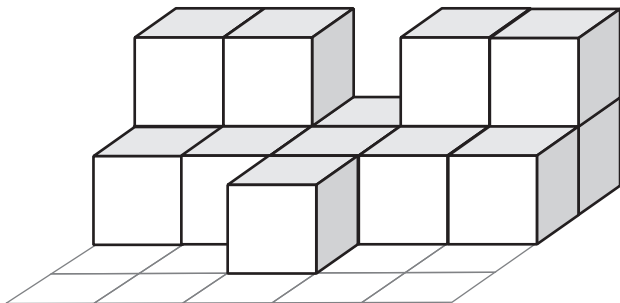

- a)
- b)
- c)**

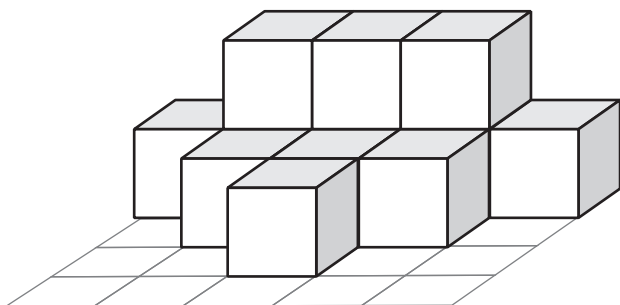

- a)**
- b)
- c)



Vogelperspektive

Beispiel:

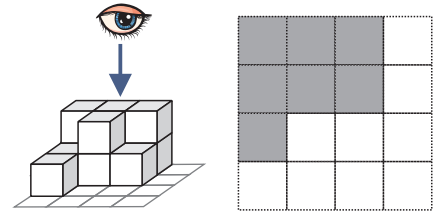

Zeichne das Bauwerk so in das Gitterfeld ein, wie man es von oben sieht.

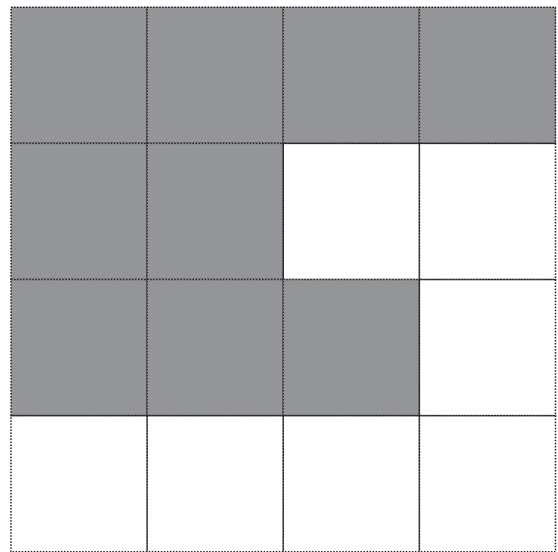
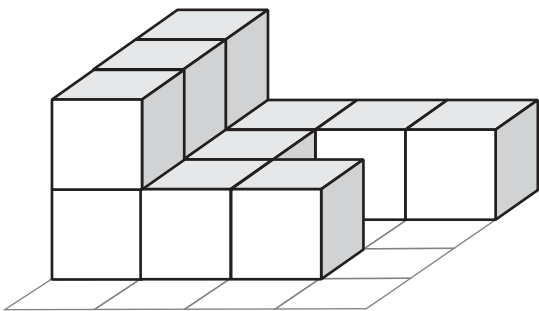
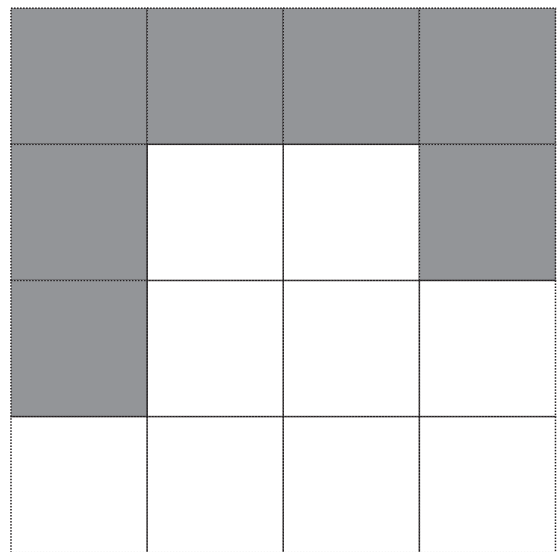
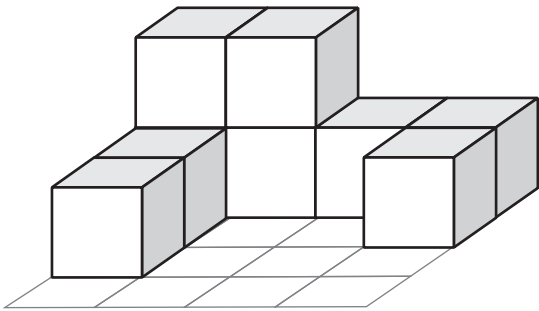



Vogelperspektive

Beispiel:

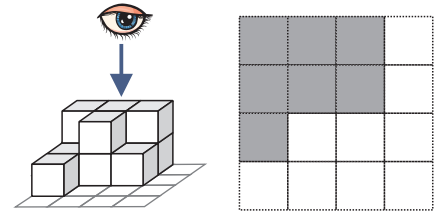

Zeichne das Bauwerk so in das Gitterfeld ein, wie man es von oben sieht.

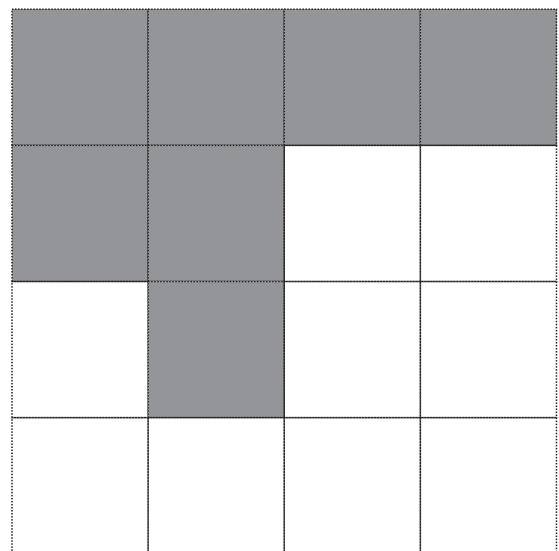
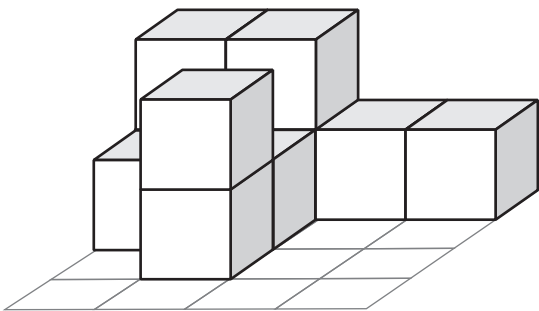
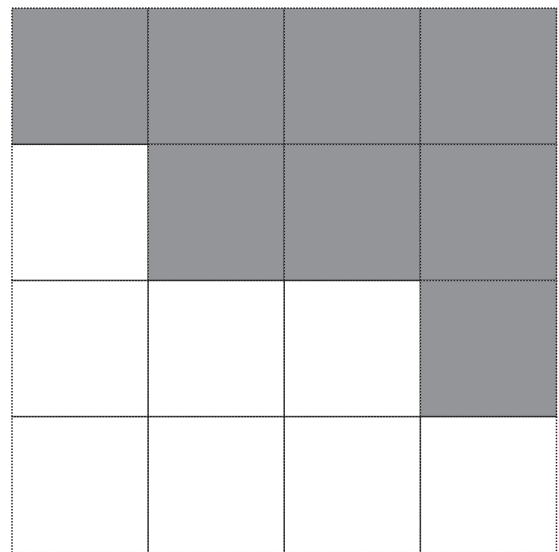
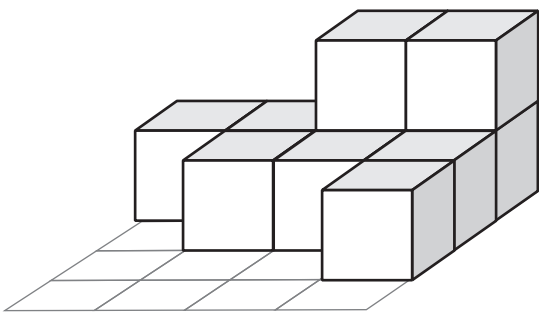



Vogelperspektive

Beispiel:

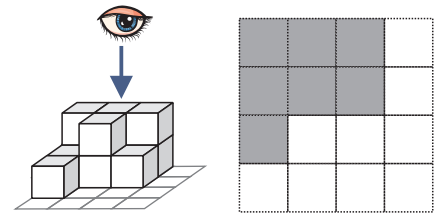

Zeichne das Bauwerk so in das Gitterfeld ein, wie man es von oben sieht.

